

KitchenAid™

*42" Built-in
Refrigerator-Freezer*

Model KSRF42D

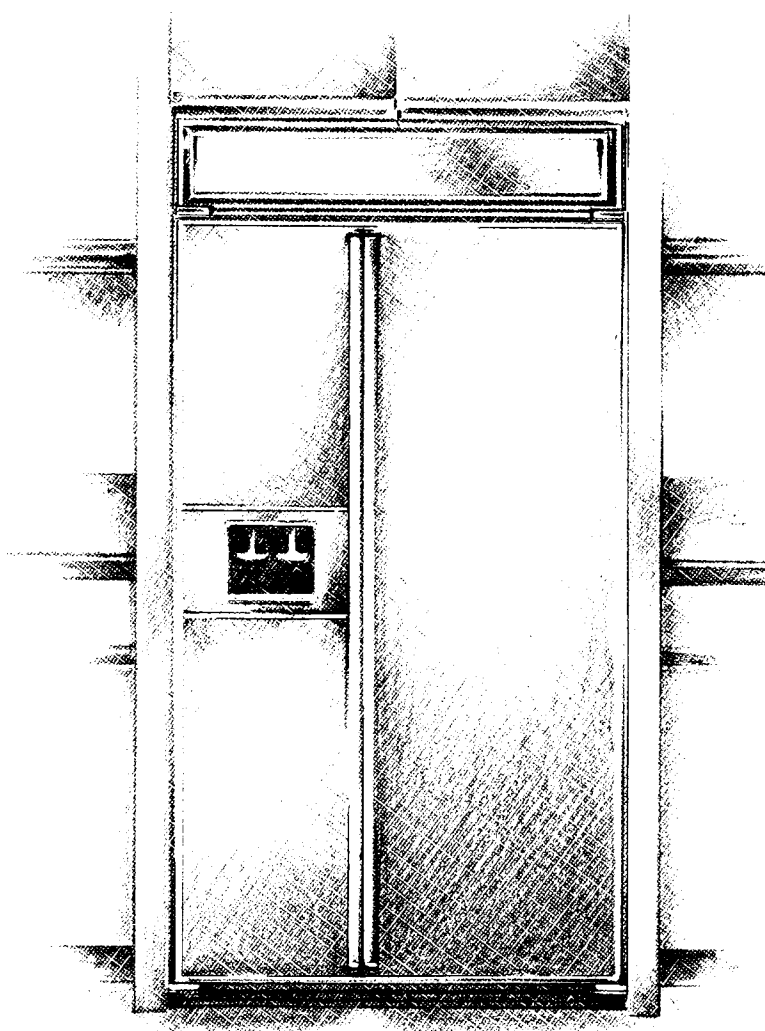

Table of Contents

	Page
Important Safety Instructions	3
Ownership Registration	4
Built-in Refrigerator-Freezer Features	5
Using the Refrigerator-Freezer	6 - 16
Temperature Controls	6
WinterChill Meat Locker	
Temperature Control	6
Utility Compartment	7
Door Bins	7
Refrigerator Shelves	7
WinterChill Meat Locker	8
Humidity Controlled ClearVue Utility	
Drawer/Crisper	9
Freezer Shelves	10
Freezer Baskets	10
Upper Ventilation Panel	11
Power On/Off Switch	11
Base Grille	12
Defrost Pan	12
Ice Maker	13
Ice Maker Storage Bin	13
Cold Water and Ice Dispenser	14
Dispenser Operating Tips	15
Sounds You May Hear	16
To Save Energy	16
Food Storage Guide	17 - 18
Changing the Light Bulbs	19
Cleaning the Refrigerator-Freezer	20
Vacation and Moving Care	21
If You Need Service or Assistance	22
KitchenAid Warranty	Back Cover

© 1989 KitchenAid, Inc.

Important Safety Instructions

To reduce the risk of fire, electrical shock, or injury when using the refrigerator, follow basic precautions including the following:

- Read all instructions before using the refrigerator.
- Child entrapment and suffocation are not problems of the past. Junked or abandoned refrigerators are still dangerous... even if they will "just sit in the garage a few days."
If you are getting rid of your old refrigerator, do it safely. Please read the enclosed safety booklet from the Association of Home Appliance Manufacturers. Help prevent accidents.
- Never allow children to operate, play with, or crawl inside the refrigerator.
- Never clean refrigerator parts with flammable fluids. The fumes can create a fire hazard or explosion.
- Always turn the power on/off switch (located behind the upper ventilation panel) to the OFF position before attempting to change light bulbs, clean, or service the refrigerator.

• FOR YOUR SAFETY •

DO NOT STORE OR USE GASOLINE OR OTHER FLAMMABLE VAPORS AND LIQUIDS IN THE VICINITY OF THIS OR ANY OTHER APPLIANCE. THE FUMES CAN CREATE A FIRE HAZARD OR EXPLOSION.

It is your responsibility to be sure your refrigerator:

- is installed and leveled on a floor that will hold the weight, and in an area suitable for its size and use.
- is connected only to the right kind of outlet, with the right electrical supply and grounding. (Refer to the Electrical Requirements and Grounding Instructions Sheet.)
- is used only to do what home refrigerators are designed to do.
- is not near an oven, radiator or other heat source.
- is properly maintained.
- is used in an area where the room temperature will not fall below 55°F (13°C).
- is not used by anyone unable to operate it properly.
- is not loaded with food before it has time to get properly cold.

– SAVE THESE INSTRUCTIONS –

Ownership Registration

Please fill out and mail your Ownership Registration Card packed with the Use and Care Guide. This card will enable us to contact you in the unlikely event of a product safety notification and assist us in complying with the provisions of the Consumer Product Safety Act. Return of this card is not necessary to validate your warranty.

You must provide proof of purchase or installation date for in-warranty service.

Write down the following information. You will need it if your refrigerator ever requires service.

Model Number* _____

Serial Number* _____

Date Purchased _____

Date Installed _____

Builder's or Dealer's Name _____

Address _____

Phone _____

*Model and serial numbers are located on a label on the right inside wall of the freezer section beneath the ice bin.

Built-In Refrigerator-Freezer Features

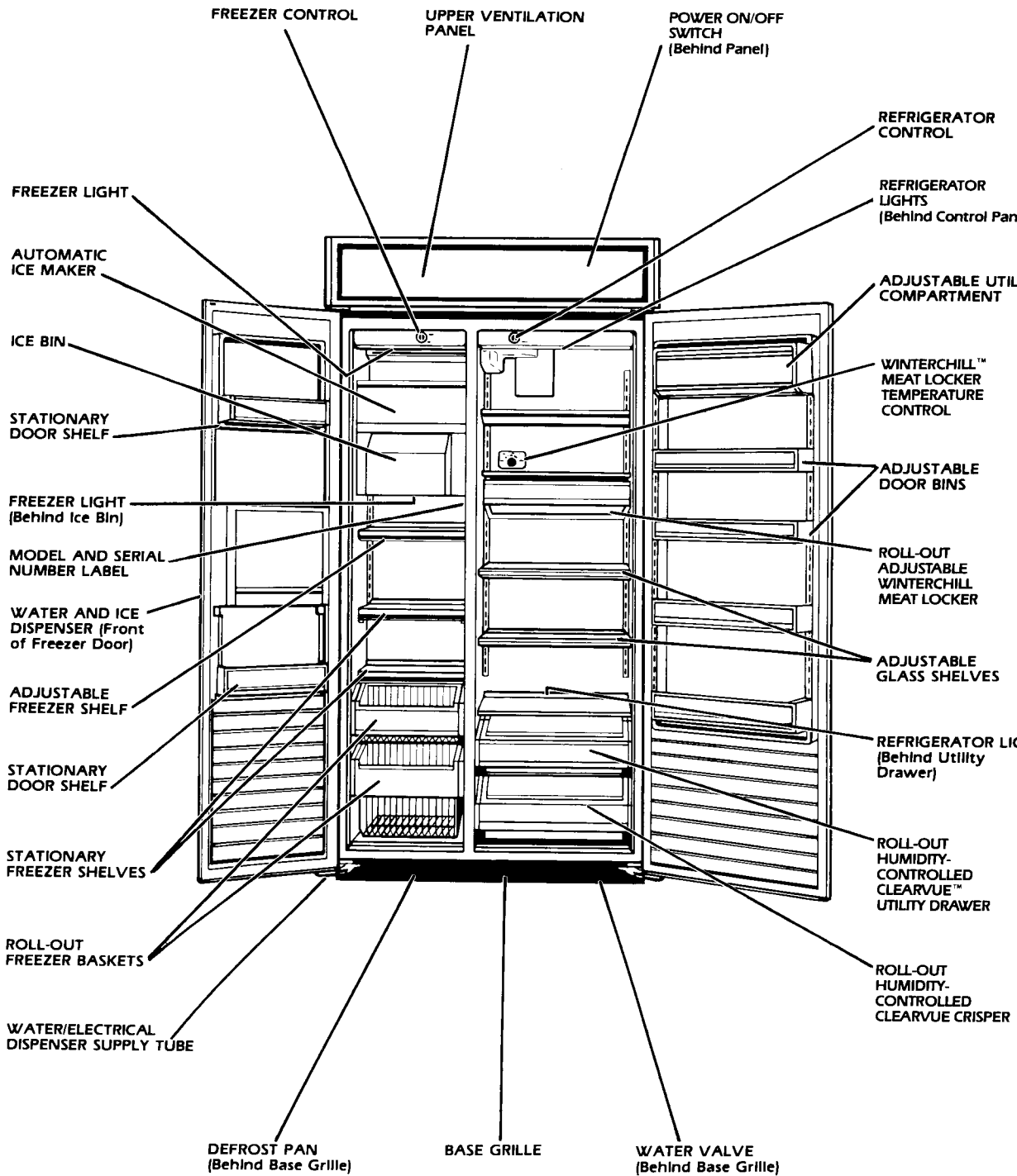

Using the Refrigerator-Freezer

Temperature Controls

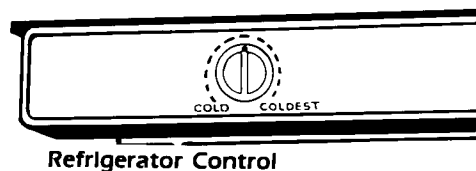
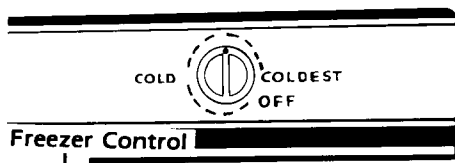

The Refrigerator and the Freezer Controls have been preset at the factory. These settings should be correct for normal household refrigerator use. Allow the refrigerator to reach the preset temperature (approximately 24 hours) before changing the setting.

To change the temperature setting, follow the two steps given below.

1. Adjust the Refrigerator and/or Freezer Control. To make the refrigerator or freezer colder, turn the control(s) clockwise. To make the refrigerator or freezer less cold, turn the control(s) counterclockwise.
2. Wait at least 24 hours before making further adjustments. This gives the refrigerator and/or freezer time to reach the set temperature.

To turn the refrigerator-freezer off, turn the Freezer Control to the OFF position.

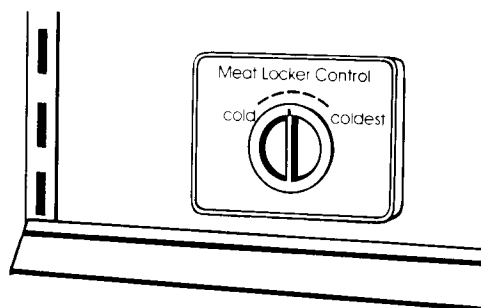

WinterChill™ Meat Locker Temperature Control

The WinterChill Meat Locker Temperature Control allows you to adjust the WinterChill Meat Locker storage temperature.

Cold air flows into the WinterChill Meat Locker through an air duct from the freezer to the refrigerator. Setting the control lets more or less cold air through the opening. See page 8 for more information on the WinterChill Meat Locker.

IMPORTANT: Freezing of items may occur in the WinterChill Meat Locker. If you do not want this to occur, turn Meat Locker Control toward "cold."

Utility Compartment

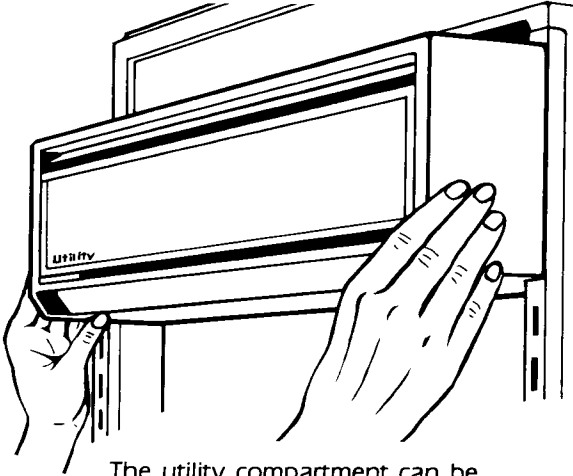

The utility compartment can be placed in any position on the refrigerator door.

TO REMOVE:

Grasp both ends of compartment, lift up and pull out.

TO REPLACE:

1. Insert compartment hooks into ladder slots on both sides.
2. Push down to lock in place.

Refrigerator Shelves

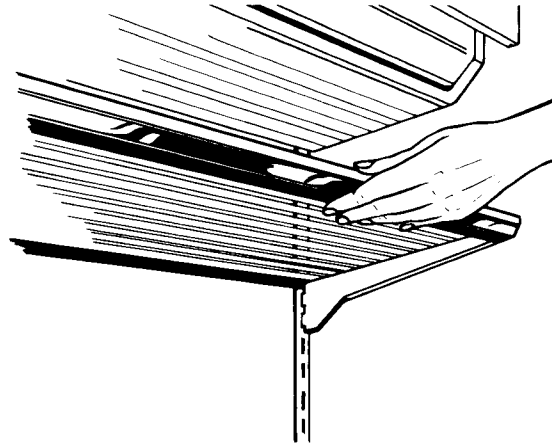

Shelves can be adjusted to match the way you use your refrigerator.

TO REMOVE:

1. Tilt up at front.
2. Lift up at back.
3. Pull shelf straight out.

IMPORTANT: Glass shelves are heavy. Handle with care.

TO REPLACE:

1. Guide the rear hooks into the ladder slots.
2. Tilt up front of shelf until hooks drop into slots. Lower front of shelf to level position. Check the stability of the shelf to be sure hooks have been properly inserted.

Door Bins

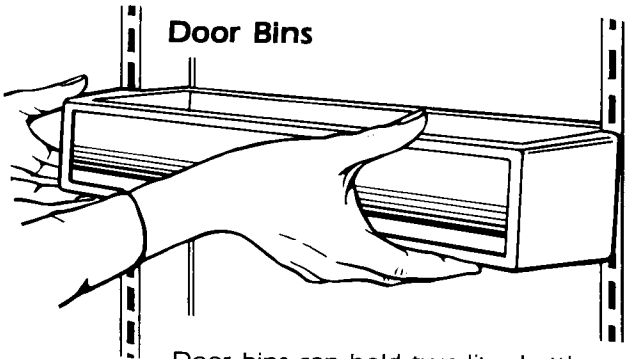

Door bins can hold two-liter bottles and can be placed in any position on the refrigerator door.

TO REMOVE:

Lift up and pull out.

TO REPLACE:

1. Insert bin hooks into ladder slots on both sides.
2. Push down to lock in place.

WinterChill™ Meat Locker

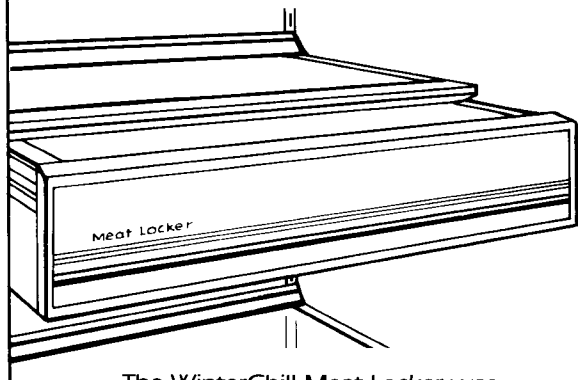

The WinterChill Meat Locker was designed to provide colder storage temperatures than the average refrigerator temperature. The Meat Locker/housing can be located in any set of ladder slots. For temperature controlled use, however, the Meat Locker and housing must be located in one of the six sets of ladder slots starting just below the WinterChill Meat Locker Temperature Control.

The WinterChill Meat Locker/housing can be removed for cleaning.

TO REMOVE MEAT LOCKER:

1. Roll out Meat Locker to stop.
2. Lift front of Meat Locker slightly.
3. Pull locker out the rest of the way.

TO REPLACE:

Replace in reverse order.

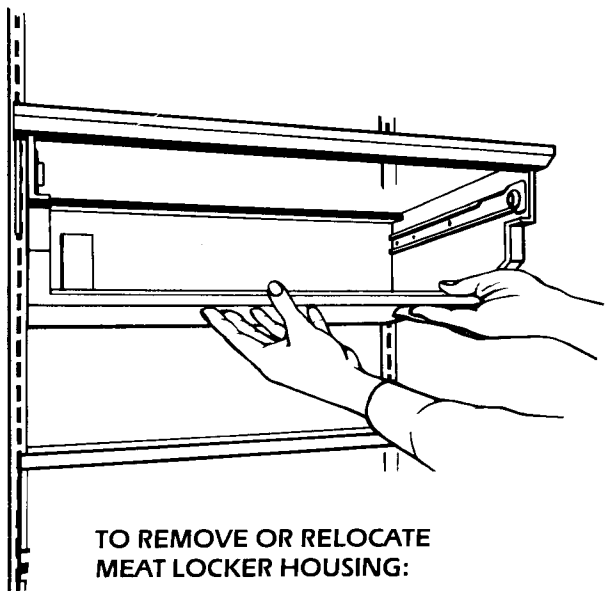

TO REMOVE OR RELOCATE MEAT LOCKER HOUSING:

1. Remove the housing in the same manner as a glass shelf.
2. Adjust chilled air supply holes:
 - A. If the housing is placed in one of the first three sets of slots below the control, put the plastic plug in the lower air supply hole. Leave the upper air supply hole open.
 - B. If the housing is placed in the fourth, fifth or sixth set of slots below the control, put the plastic plug in the upper air supply hole. Leave the lower air supply hole open.
 - C. If the housing is placed in any other set of slots, plug both the upper and lower air supply holes. A second plug has been taped to the inside bottom of the Meat Locker for this purpose.
3. Replace the housing in the same manner as a glass shelf.

Humidity-Controlled ClearVue™ Utility Drawer/Crisper

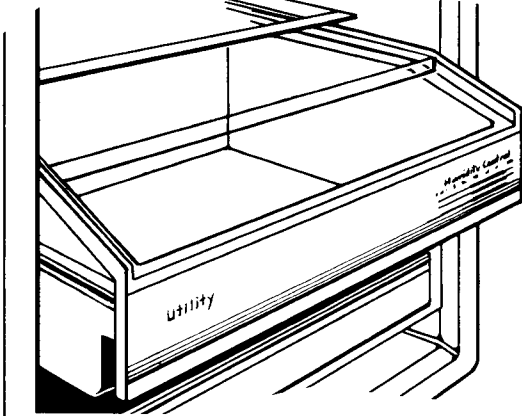

The humidity controls give you the ability to change the amount of moisture in the drawer/crisper according to what foods you store in them. See the Food Storage Guide on page 17 to determine which humidity setting to use. Move the lever to the right for higher humidity or to the left for lower humidity. The humidity-controlled utility drawer and the crisper are interchangeable. The ClearVue Section allows you to see into the drawer/crisper without opening them.

TO REMOVE UTILITY DRAWER/CRISPER:

1. Roll out to stop.
2. Lift front and pull out the rest of the way.

TO REPLACE:

Replace in reverse order.

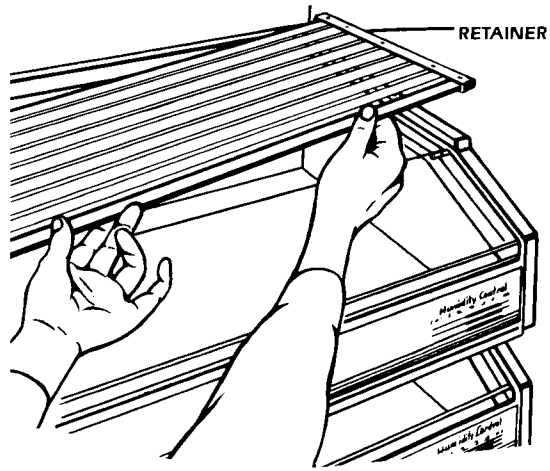

TO REMOVE GLASS COVERS:

1. Lift right side of glass cover to free retainer and left side of cover.
2. Carefully remove glass cover.

TO REPLACE:

1. Place retainer on right side of glass cover.
2. Insert left side of glass cover into groove.
3. Lower cover so that retainer pins are in the guide holes.

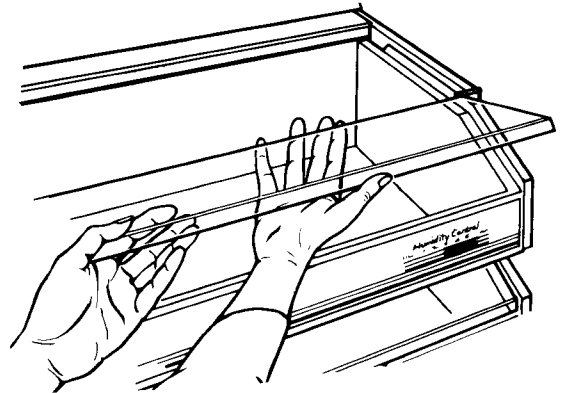

TO REMOVE CLEARVUE SECTION:

1. Remove glass cover. (See above.)
2. Lift off ClearVue section.

TO REPLACE:

Replace in reverse order.

Freezer Shelves

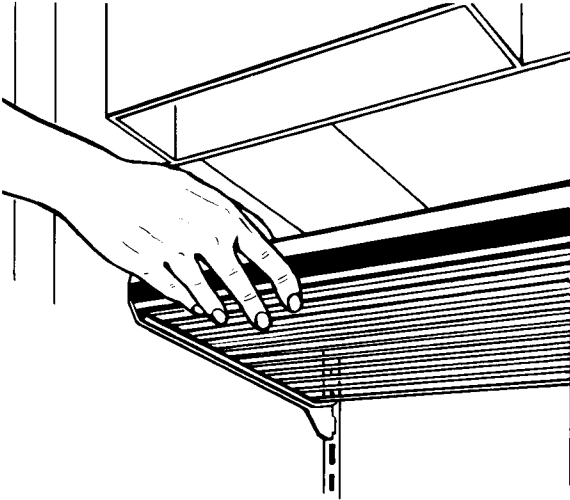

TO REMOVE LADDER-MOUNTED SHELF:

1. Tilt up at front.
2. Lift up at back.
3. Pull shelf straight out.

TO REPLACE:

1. Guide the rear hooks into the ladder slots.
2. Tilt up front of shelf until hooks drop into slots.
3. Lower front of shelf to level position.

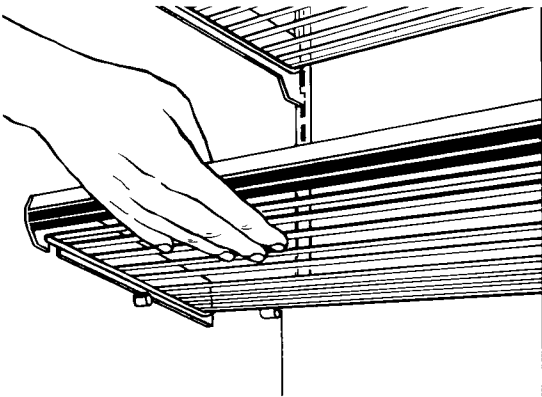

TO REMOVE STUD-MOUNTED SHELF:

1. Lift up shelf.
2. Pull straight out.

TO REPLACE:

Replace in reverse order.

Freezer Baskets

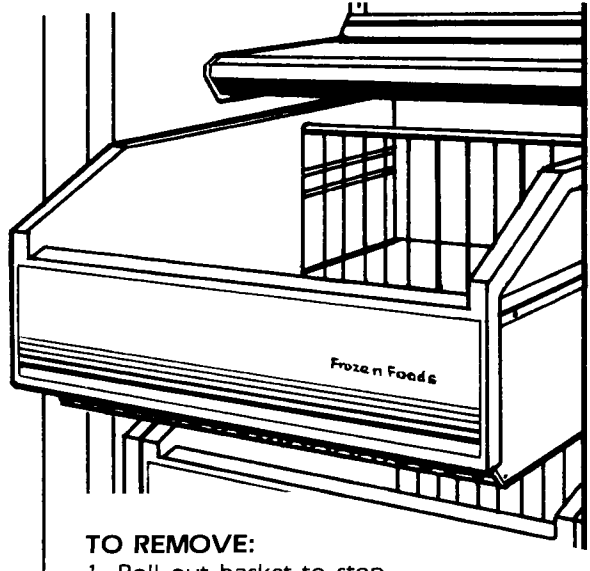

TO REMOVE:

1. Roll out basket to stop.
2. Lift front and roll out the rest of the way.

TO REPLACE:

1. Place basket roller in shelf tracks.
2. Lift front of basket to clear the stops.
3. Roll basket in.

Upper Ventilation Panel

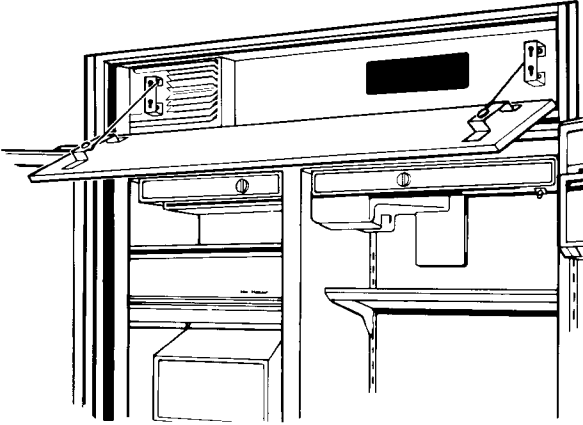

TO REMOVE:

1. Grasp both ends of the panel.
2. Push straight up, then pull straight out.
3. A cable on each side of the upper ventilation panel attaches it to the grille assembly. The upper ventilation panel can be suspended by these cables while cleaning the condenser or turning off the power on/off switch.

TO REPLACE:

1. Insert screw heads on the back side of upper ventilation panel into the large part of the keyhole openings.
2. Pull panel down slightly to lock into place.

Power On/Off Switch (Power Interrupter Switch)

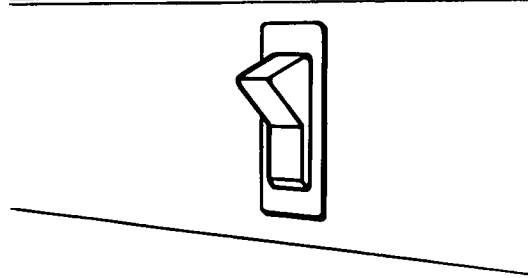

The power on/off switch is located behind the upper ventilation panel. It is used to turn the power to the refrigerator-freezer off when cleaning or changing light bulbs.

TO TURN POWER OFF:

1. Remove upper ventilation panel.
2. Press power on/off switch to OFF position.

TO TURN POWER ON:

1. Press power on/off switch to ON position.
2. Replace upper ventilation panel.

IMPORTANT: Be sure power on/off switch is in the ON position after cleaning or changing light bulbs.

Base Grille

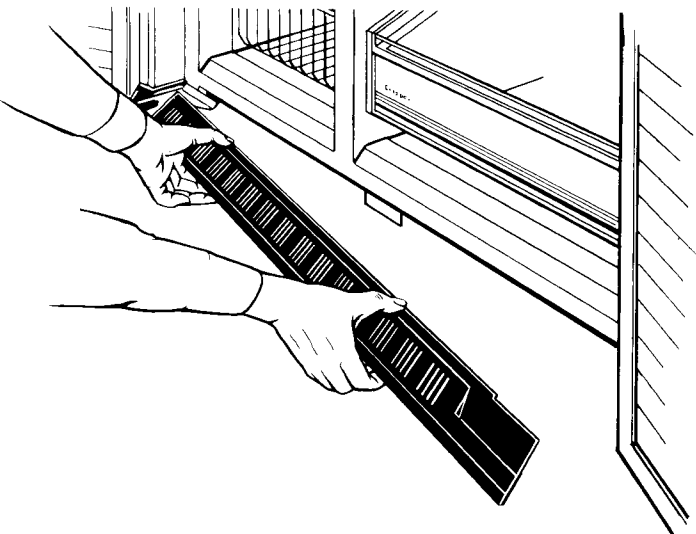

TO REMOVE BASE GRILLE:

1. Remove one screw at each end of the grille.
2. Remove base grille.

TO REPLACE BASE GRILLE:

Replace in reverse order.

Defrost Pan

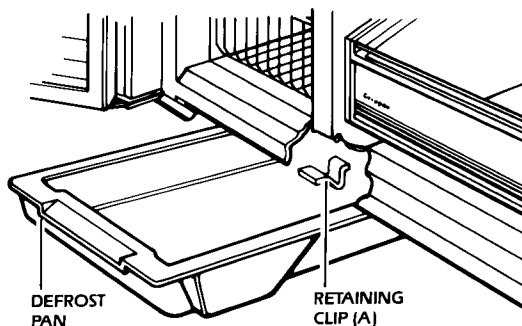

The defrost pan is located behind the base grille toward the left side of the refrigerator-freezer.

Personal Injury Hazard

Refrigeration system tubes are located above the defrost pan and can become hot. Remove and install defrost pan carefully. Failure to do so could cause personal injury.

TO REMOVE DEFROST PAN:

1. Press power on/off switch to OFF position. (See page 11 for instructions.)
2. Remove base grille.
3. Locate retaining clip (A) under refrigerator.
4. Push up on the clip and at the same time slide the pan forward and out.
5. Clean the pan. (See page 20 for instructions.)

TO REPLACE DEFROST PAN:

1. Position the edge of the pan about 7 inches from left side of the refrigerator.
2. Lift pan into side glides and push back into place. (You should hear a click or snap.)
3. Replace base grille.
4. Return power on/off switch to ON position.

Ice Maker

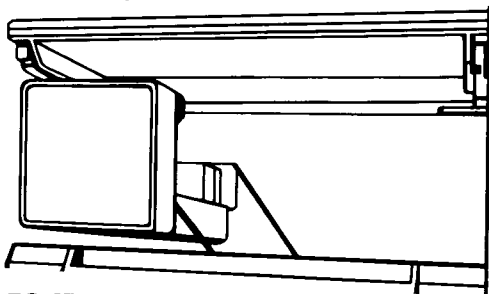

TO START ICE MAKER:

Push the ice maker signal arm down to the ON position.

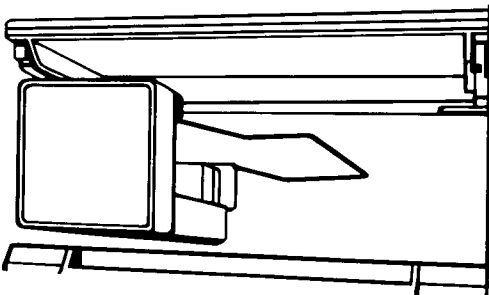

TO STOP ICE MAKER:

Lift the ice maker signal arm until you feel it click into the OFF position.

Ice Maker Storage Bin

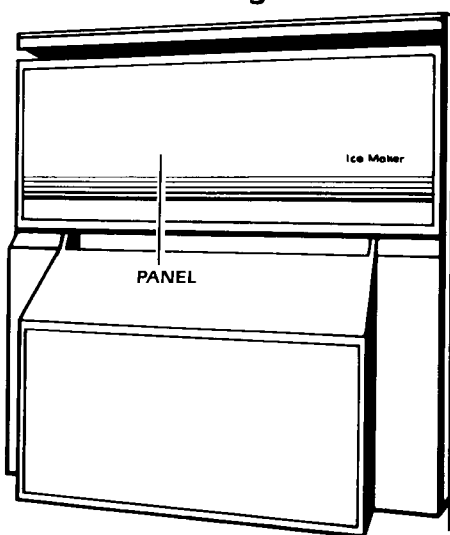

The ice maker storage bin can hold up to 8.5 pounds of ice. Remove unused ice periodically to reduce the potential for off-taste or odor build-up in ice.

IMPORTANT: The first few batches of ice from the ice maker may have an off-taste. This is from new plumbing and parts, and the ice should be thrown away.

TO REMOVE STORAGE BIN:

The storage bin can be removed to dispense large quantities of ice or for cleaning.

1. Pull the covering panel out from the bottom and slide it to the rear.
2. Lift the ice maker signal arm until you feel it click into the OFF position. Ice can still be dispensed when the freezer door is closed, but no more can be made.
3. Lift the front of the storage bin, then pull it out.
4. Empty the bin. Use hot or warm water to melt the ice if necessary. Never use anything sharp to break up ice in the bin. This can damage the bin and dispenser mechanism.
5. Wash with mild detergent. Rinse well. Do not use harsh or abrasive cleaners or solvents.

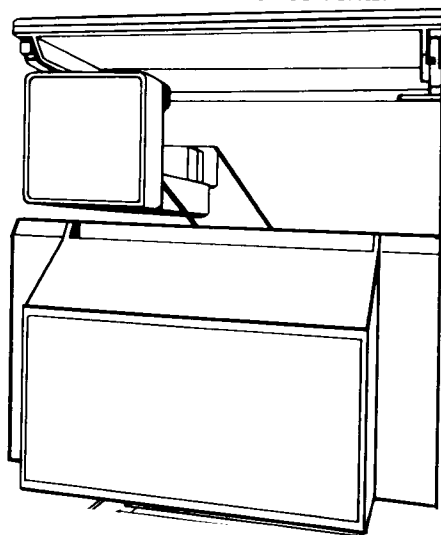

TO REPLACE STORAGE BIN:

1. Make sure bin is pushed in all the way.
2. Push the ice maker signal arm down to the ON position to restart ice production.
3. Lower covering panel.

Cold Water and Ice Dispenser

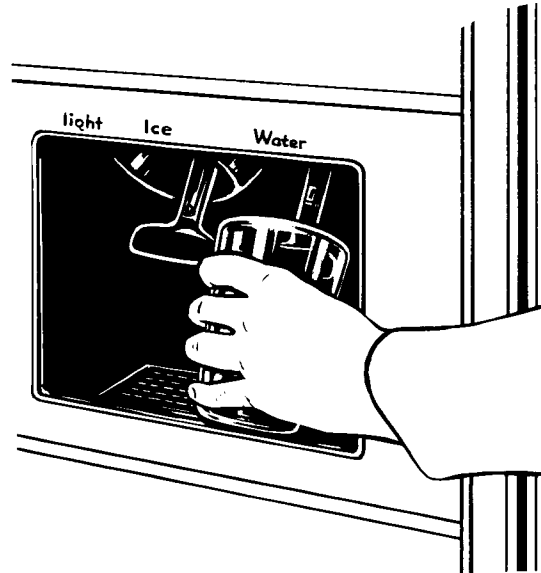
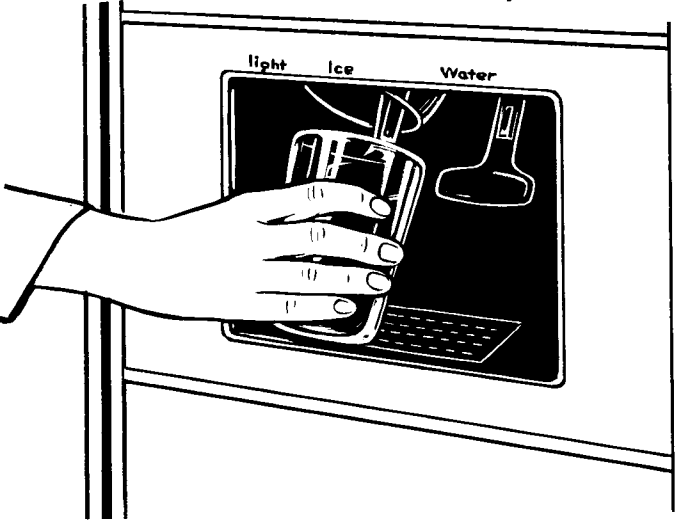

Personal Injury Hazard

Tumbling ice and pressure on a fragile glass can break it. Do not use a fragile glass when dispensing ice or water. Failure to do so could result in personal injury or breakage.

TO DISPENSE ICE:

Press a sturdy glass against the ice dispenser bar. Remove the glass to stop dispensing.

Ice is dispensed from the ice maker storage bin in the freezer. When the dispenser bar is pressed, a trap door opens in a chute between the dispenser and the ice bin. Ice is moved from the bin and falls through the chute. When the dispenser bar is released, a buzzing sound may be heard for a few seconds.

TO DISPENSE CHILLED WATER:

Press a sturdy glass against the water dispenser bar. Remove the glass to stop dispensing.

Chilled water comes from a 50 oz. tank behind the crisper/utility drawers. Allow about 24 hours to chill the first tankful of water.

When the refrigerator is first hooked up, press the water dispenser bar with a glass or jar until you have drawn and discarded 2-3 quarts of water. This will remove the air in the system and rinse the tank and pipes.

If the dispenser is not used regularly, dispense enough water every week to freshen the supply. Allow 2-3 hours for the new supply of water to chill.

IMPORTANT: The small tray under the dispenser is designed to evaporate **small** spills. There is no drain in this tray. Do not pour water into it.

Dispenser Operating Tips

- The ice dispenser will work only with the freezer door closed.
- The ice dispenser will work only if the bin is pushed all the way in.
- Use only ice crescents from the ice maker. Other shapes will not dispense properly.
- When you need more ice than a glass or two, scoop it from the ice bin. The dispenser motor may stop if the dispenser bar is held in too long. If this happens, wait about 3 minutes for the motor's protective device to reset itself.
- Good water quality is important for good ice quality. It is not recommended that the ice maker be connected to a softened water supply. Water softener chemicals such as salt from a malfunctioning softener can damage the ice maker mold and lead to poor quality ice. If a softened water supply cannot be avoided, it is important that the water softener be well maintained and is operating properly.
- An off-taste or odor in the ice can be eliminated by making sure food is wrapped and stored properly and/or by throwing away stale ice and making a new supply.

IMPORTANT: The first few loads of ice from a new ice maker may have an off-taste. Throw away the ice and make a new supply.

Sounds You May Hear

Your new refrigerator may make different sounds than your previous one. Hard surfaces such as the ceiling, walls, and cabinets around the refrigerator can make sounds seem louder.

The following chart describes the kinds of sounds that might be new to you and what causes them.

Sounds/Observations	Causes
Hum or Hiss	The refrigerator's fan motor and moving air.
Clicking or Snapping Sounds	The thermostat makes a definite click when the refrigerator stops running. It also makes a sound when the refrigerator starts. The defrost timer will click when the defrost cycle starts and stops.
Ice Maker Sounds •trickling water •clatter of ice	You may hear buzzing (from the water valve), trickling water and the clatter of ice falling into the bin.
Running Sounds	The high-efficiency compressor and motor will run longer than older designs.
Trickling Water/Water Sounds	During the defrost cycle, the refrigerator will not be running. The trickling water is the frost accumulation on the freezer coil melting and running into the defrost pan. When the refrigerator stops running, you may hear gurgling in the tubing for a few minutes.
Warm Air from Upper Ventilation Panel/Base Grille	You may feel air flowing from behind the upper ventilation panel and base grille when the refrigerator is running. This is normal.

To Save Energy

- Open the doors as few times as possible. Keep food organized so you do not have to search for what you want. Get everything you need out at one time. Close the door as soon as food is removed.
- Fill the refrigerator, but do not overcrowd it so air movement is blocked.
- Set the refrigerator and freezer temperatures to suit your needs—ice cream should be firm and beverages should be as cold as you like them. Avoid setting the refrigerator and freezer temperatures colder than is necessary.

Food Storage Guide

Fresh Food

Vegetables

- Leafy
Remove store wrapping. Tear off bruised and discolored areas. Wash in cool water, drain. Place in plastic bag or container and store in crisper or utility drawer on high humidity setting.
- With Skins
Place in plastic bags or containers and store in crisper or utility drawer on low humidity setting.

Fruit

- Berries
Sort to remove injured berries. Do not wash berries until they are to be served. Store in original container in crisper or utility drawer on low humidity setting.
- Other
Sort to remove injured fruit before storing. Wash fruit, let dry, place in perforated plastic bag or loosely covered plastic container and store in crisper or utility drawer on low humidity setting.

Meat

- Cured or Smoked Meat and Cold Cuts
Store in original packaging in Meat Locker until opened. When opened, tightly re-wrap using plastic wrap or aluminum foil and store in Meat Locker.
- Fresh, Prepackaged Meat & Poultry
Store in original packaging in Meat Locker.
- Fresh Meat, Not Prepackaged
Remove market wrapping paper. Rewrap in aluminum foil and store in Meat Locker.
- Fresh Poultry, Not Prepackaged
Remove market wrapping paper. Rewrap in plastic wrap and store in Meat Locker.
- Cooked Meat & Poultry
Wrap or cover with plastic wrap or aluminum foil. Store immediately.
- Fresh Fish & Shellfish
Store in plastic bag or tightly covered container in Meat Locker. Set Meat Locker control on coldest setting for best results.

Dairy Products

- Eggs
Store in original carton or use the Egg Nest in the refrigerator.
- Milk
Store in original container on refrigerator shelf.
- Butter or Margarine
Store in the utility compartment or on refrigerator shelf until opened. When opened, store in covered dish or on butter dish in the utility compartment.
- Cheese
Store in original packaging until opened. When opened, tightly rewrap in plastic wrap or aluminum foil and store in utility compartment or on refrigerator shelf.

Leftovers

Cover with plastic wrap or aluminum foil, or place in plastic containers with tight fitting lids.

Condiments

Store small jars and bottles in door bins.

Beverages

Wipe off bottles and cans. Store in door bins or on refrigerator shelves. Door bins will hold two-liter bottles.

Refrigerator Storage Chart for Fresh and Cured Meat*

Type	Approximate Time (Days)
Chicken	1 to 2
Ground Beef	1 to 2
Variety Meat	1 to 2
Steaks and Roasts	3 to 5
Cold Cuts	3 to 5
Bacon	5 to 7
Cured Meat	7 to 10

*If meat is to be stored longer than the times given, freezing is recommended.

IMPORTANT: Fresh fish and shellfish should be used the same day as purchased.

Frozen Food

Prepackaged Frozen Food

Store in original packaging on freezer door shelf or on freezer shelf.

Meat/Poultry

Trim off excess fat and remove bones when necessary. Meat/Poultry should not be salted. Wrap tightly in heavy-duty aluminum foil, plastic-coated wrapper, or non-permeable plastic wraps (made from a saran film). Press out as much air as possible. Label and date the meat/poultry. Do not refreeze thawed meat.

Ice Cream

Store in original packaging. When opened, place piece of aluminum foil or waxed paper against ice cream surface to prevent the formation of ice crystals.

Frozen Juices

Store in original container on freezer door shelf or on freezer shelf.

Storage Chart for Frozen Food

Storage times given in this chart are only a guide. For best use of freezer space, keep frozen food for short times. Use, then replace as needed.

Type	Approximate Time (Months)
Bread	2
Cooked Dishes	2 to 3
Fish and Seafood	
Fresh	6
Commercially Frozen	1 to 3
Fruit	6
Ice Cream	1
Concentrated Juice	4 to 6
Meat	
Bacon	less than 1
Pork Roast, Chops	3 to 4
Sausage	1 to 2
Beef, Veal, Lamb Roasts	6
Ground Meat	1 to 2
Poultry	3 to 4
Vegetables	6

Courtesy of National Livestock & Meat Board and U.S.D.A.

Changing the Light Bulbs

Electrical Shock Hazard

Before removing a light bulb, turn off the electricity leading to the refrigerator at the power on/off switch located behind the upper ventilation panel. Failure to do so could result in electrical shock or personal injury.

Light Bulbs Behind the Refrigerator and Freezer Controls:

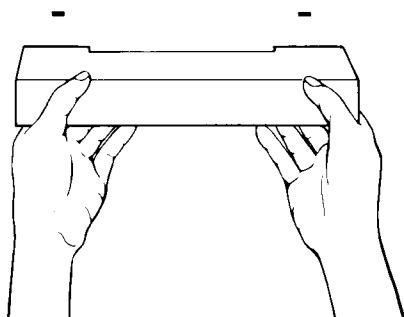

TO REMOVE:

1. Grasp plastic light cover with both hands and squeeze (front to back) to release tabs.
2. Pull down and away from controls.
3. Remove bulb.

TO REPLACE:

1. Replace light bulbs with 25-watt incandescent medium-base tubular bulbs.
2. Insert tabs of plastic cover into slots.
3. Push to snap into place.

Light Bulb Under the Ice Bin:

1. Remove light cover.
2. Remove and replace the bulb with a 25-watt incandescent medium-base tubular bulb.
3. Replace light cover.

Light Bulb Behind the Crisper:

1. Remove utility drawer/crisper. (See page 9 for instructions.)
2. Remove glass cover of utility drawer/crisper. (See page 9 for instructions.)
3. Pull bottom of light cover away from back wall of refrigerator. Remove light cover.
4. Remove and replace the bulb with a 25-watt incandescent medium-base tubular bulb.
5. Replace the light cover in the reverse order.

Dispenser Light:

1. Remove the bulb from the top inside of the dispenser area.
2. Replace with a heavy-duty 10-watt bulb.

IMPORTANT: Be sure power on/off switch is returned to the ON position after the light bulbs have been changed.

Cleaning the Refrigerator-Freezer

The refrigerator and freezer sections defrost automatically. However, both should be cleaned once a month to help prevent odors from building up. Spills should be wiped up immediately.

To clean, turn off the electricity at the power on/off switch behind the upper ventilation panel; take out all removable parts and clean it according to the directions given below. Be sure power on/off switch is in the ON position when cleaning is finished.

Cleaning Chart

Part	What To Use	How To Clean
Removable parts (shelves, meat locker, crisper, utility drawers, etc.)	<ul style="list-style-type: none"> • Sponge or cloth • Mild detergent and warm water 	<ul style="list-style-type: none"> • Wash with warm water and a mild detergent. • Rinse and dry well.
Interior walls	<ul style="list-style-type: none"> • Sponge, soft cloth or paper towel • Mild detergent • Warm water 	<ul style="list-style-type: none"> • Wash with warm water and mild detergent. • Rinse and dry well.
Door liners and gaskets	<ul style="list-style-type: none"> • Sponge, soft cloth or paper towel • Mild detergent • Warm water 	<ul style="list-style-type: none"> • Wash with mild detergent and warm water • Rinse and dry well. • Do not use cleaning waxes, concentrated detergents, bleaches, or cleaners containing petroleum or alcohol on plastic parts.
Base grille	<ul style="list-style-type: none"> • Vacuum cleaner with brush attachment 	<ul style="list-style-type: none"> • Vacuum grille with brush attachment.
Defrost Pan	<ul style="list-style-type: none"> • Sponge or cloth • Mild detergent • Warm water 	<div data-bbox="787 1081 1228 1342" style="border: 2px solid black; padding: 5px;"> <p align="center">Personal Injury Hazard Refrigeration system tubes are located above the defrost pan and can become hot. Remove and install defrost pan carefully. Failure to do so could cause personal injury.</p> </div> <ul style="list-style-type: none"> • Press power on/off switch OFF. (See page 11.) • Remove base grille. (See page 12.) • Remove defrost pan. (See page 12.) • Wash defrost pan in warm water and mild detergent. • Rinse and dry well. • Replace defrost pan. • Replace base grille. • Press power on/off switch ON.
Panels		<ul style="list-style-type: none"> • Clean as you would your kitchen cabinets.
Condenser Coils	<ul style="list-style-type: none"> • Vacuum cleaner with extended narrow attachment 	<ul style="list-style-type: none"> • Should be cleaned periodically. • Remove upper ventilation panel (see page 11) to expose condenser coils. • Vacuum using extended narrow attachment. • Replace upper ventilation panel.

Vacation and Moving Care

Short Vacations

If you will be away for less than four weeks, there is no need to shut off the refrigerator. Use up perishables and freeze other items. Turn off the automatic ice maker, then shut off the water supply to the ice maker. Empty the ice bin.

Long Vacations

Remove all food if you will be gone a month or more. Turn off the water supply to the ice maker at least one day ahead of time. When the last load of ice drops into the bin, turn the ice maker off. Turn the refrigerator-freezer off. (See page 6.)

To restart the refrigerator, see Using the Refrigerator-Freezer, page 6.

Moving

If the refrigerator-freezer must be moved, contact the dealer from whom you purchased the refrigerator-freezer or your local KitchenAid authorized servicer.

If You Need Service or Assistance

1. If the refrigerator should fail to operate, review the following list before calling your dealer. You could save the cost of a service call.

If the refrigerator will not operate:

- Is the power on/off switch (located behind the upper ventilation panel) in the OFF position?
- Is a fuse blown or circuit breaker tripped?
- Is the Freezer Control in the OFF position?

If the refrigerator makes unfamiliar sounds:

- New features on your refrigerator make new sounds. You may be hearing air flowing from fans, timer clicks for the defrosting cycle, or defrost water draining into the defrost pan. See page 16.

If your ice maker will not operate:

- Has the freezer had enough time to get cold?
- Is the signal arm ON, in the down position?
- Is the water line valve turned on? Is water getting to the ice maker?

If the lights are not working:

- Is the power on/off switch (located behind the upper ventilation panel) in the OFF position?
- Is a fuse blown or circuit breaker tripped?
- Is the light bulb burned out? See instructions for changing light bulbs on page 19.

If the motor seems to run too long:

- The motor naturally runs longer on hot days or if the room is warm, as well as when a large amount of food has been put into the refrigerator or the doors have been opened a lot.

2. If the problem is not due to one of the above items:

- Call your dealer or the repair service he recommends.
- All service should be handled locally by the dealer from whom you purchased the refrigerator or an authorized KitchenAid servicer.

3. In the event you are unable to obtain the name of a local authorized KitchenAid servicer:

- Call KitchenAid Customer Relations, TOLL FREE **800-422-1230**. A Customer Relations representative can recommend a qualified service company in your area.

- If you must call or write, please provide: Model Number, Serial Number, Date of Purchase and a complete description of the problem. Write to:
Customer Relations Department
KitchenAid, Inc.
P.O. Box 558
St. Joseph, MI 49085-0558

Please include a daytime phone number in your correspondence.

4. If you are not satisfied with the action taken:

- Contact the Major Appliance Consumer Action Panel (MACAP). MACAP is a group of independent consumer experts that voices consumer views at the highest levels of the major appliance industry.

- Contact MACAP only when the dealer, authorized servicer, or KitchenAid, Inc. have failed to resolve your problem.

Major Appliance Consumer
Action Panel
20 North Wacker Drive
Chicago, IL 60606

- MACAP will in turn inform us of your action.

KitchenAid

Built-in Refrigerator Warranty

LENGTH OF WARRANTY:	KITCHENAID WILL PAY FOR:	KITCHENAID WILL NOT PAY FOR:
ONE YEAR FULL WARRANTY: FROM DATE OF INSTALLATION	Replacement parts and repair labor to correct defects in materials or workmanship. Service must be provided by an authorized KitchenAid servicing outlet.	A. Service calls to: 1. Correct the installation of the refrigerator. 2. Instruct you how to use the refrigerator.
FIVE YEAR FULL WARRANTY: FROM DATE OF INSTALLATION	Replacement parts and repair labor to correct defects in materials or workmanship in the sealed refrigeration system. These parts are: 1. Compressor 2. Evaporator 3. Condenser 4. Drier 5. Connecting Tubing. Service must be provided by an authorized KitchenAid servicing outlet.	3. Replace house fuses or correct house wiring. 4. Correct house plumbing. B. Repairs when refrigerator is used in other than normal home use. C. Damage resulting from accident, alteration, misuse, abuse, improper installation or installation not in accordance with local electrical or plumbing codes.
FIVE YEAR FULL WARRANTY: FROM DATE OF INSTALLATION	Replacement parts and repair labor to correct defects in materials or workmanship in the automatic ice maker. Service must be provided by an authorized KitchenAid servicing outlet.	D. Any food loss due to product failure. E. Replacement parts or repair labor costs for units operated outside the United States.
TEN YEAR LIMITED WARRANTY FIVE YEAR FULL PLUS SIXTH THROUGH TENTH YEAR LIMITED FROM DATE OF INSTALLATION	Replacement parts to correct defects in materials or workmanship in the sealed refrigeration system. These parts are: 1. Compressor 2. Evaporator 3. Condenser 4. Drier 5. Connecting Tubing.	F. Pick up and delivery. This product is designed to be repaired in the home. G. Any labor costs during the Limited Warranty.

KITCHENAID, INC. DOES NOT ASSUME ANY RESPONSIBILITY FOR INCIDENTAL OR CONSEQUENTIAL DAMAGES. Some states do not allow the exclusion or limitation of incidental or consequential damages, so this exclusion or limitation may not apply to you.

This warranty gives you specific legal rights and you may also have other rights which vary from state to state.

KitchenAid, Inc.
St. Joseph, Michigan, U.S.A. 49085